

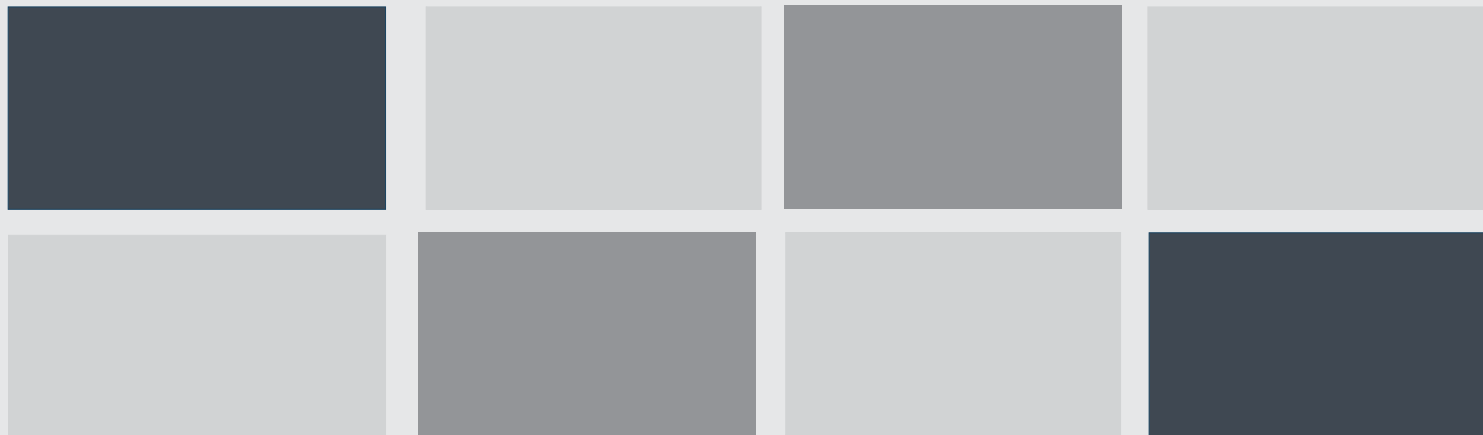

Siargo Ltd.



Model FS6122H

SIARGO MEMS FLOW SENSING PRODUCTS

Integrated Sensors for CPAP Applications

VA.0



© 2017 Siargo Ltd.



Siargo Ltd.

Integrated MEMS Sensors for CPAP Applications

FS6122H Series

User Manual

Document No. 01-2017-S8H EN

Issue date: 2017.01

Revision: VA.0

Siargo Ltd.

3100 De La Cruz Boulevard,
Suite 210,
Santa Clara, CA 95054
USA

Tel: +1(408)969.0368

Email: info@siargo.com

© Copyright 2016 by Siargo Ltd.

Siargo Ltd. and its subsidiaries reserve the rights to change the specifications and/or descriptions without prior notice. For further information and updates, please visit: www.Siargo.com

Integrated MEMS Sensors for CPAP



Siargo Ltd.

Model FS6122H

1. Features

- Specially designed for medical CPAP applications
- Direct measurement of mass flow rate and gauge pressure
- Optional humidity and temperature sensors
- Small dead volume with compact form factor
- Digital and analog linear output with fast response time

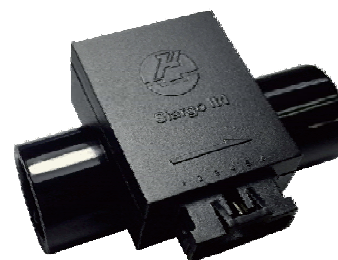

2. Sensor Performance

All data unless otherwise noted apply for calibration conditions: air, 20 °C, 101.325 kPa absolute pressure, horizontal mounting.

		Vaule	Unit
Flow Sensor	Flow Range ¹	-250 ~ +250	SLPM
	Accuracy (Total Error Band)	± (2.5 + 0.5FS)	%
	Output	Linear, Analog/I ² C (14bit)	
	Analog Output ²	0.5 ~ 4.5	Vdc
	Response Time	2	ms
Pressure Sensor	Pressure Type	Gauge	
	Pressure Range	-5 ~ +40 / -5 ~ +100	cmH ₂ O
	Total Accuracy	± 1.0	%FS
	Output	Linear, Analog/I ² C (14bit)	
	Analog Output ²	0.5 ~ 4.5	Vdc
	Update Time	<1	ms
Temperature & Humidity sensor	Temperature	-10 ~ 60	°C
	Accuracy	± 0.5	%
	Humidity	0~100 (No icing or condensation)	%RH
	Accuracy	±2.0 (20~80%RH); ±5.0 max (other ranges)	%RH
	Resolution	0.7	%RH
	Response time (63%)	5.0 (25~75%RH)	sec
	Stability	0.5	%RH/year

Other Specifiactions

Gas Type	Air	
Supply Voltage	5.0 ± 5%	Vdc
Supply Current	25	mA
Output Pin SN6-50	6 Pins, NS-TECH CD R-6; 0.5m	
Compensated Temperature	-5 ~ +65	°C
Compensated Altitude	-400 ~ +3000 (700 ~ 1060)	m (hPa)
Storage Temperature	-40 ~ +85	°C
Warming Up Time	<50	ms

*Pressure and/or humidity & temperature sensor could be optional, see detailed order information in section 5.

1, Other flow ranges are available, see detailed order information in section 5.

2, Corresponding to the value from reverse full scale to forward full scale.

3, Maximum pressure base on the working pressure of the pressure sensor.

Pressure range: -5 ~ + 40 cmH₂O, proof pressure: ±30 kPa, burst pressure: ±40 kPa.

Pressure range: -5 ~ + 100 cmH₂O, proof pressure: ±80 kPa, burst pressure: ±100 kPa.



3. Performance Characteristics

Flow Rate (SLPM)	Typical Voltage (Vdc)
-250	0.500
-200	0.900
-150	1.300
-100	1.700
-50	2.100
0	2.500
+50	2.900
+100	3.300
+150	3.700
+200	4.100
+250	4.500

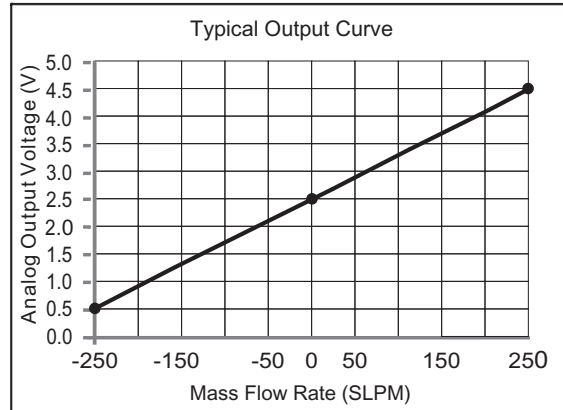

Pressure (cmH ₂ O)	Typical Voltage (Vdc)
-5	0.500
0	0.944
+5	1.389
+10	1.833
+15	2.278
+20	2.722
+25	3.167
+30	3.611
+35	4.056
+40	4.500

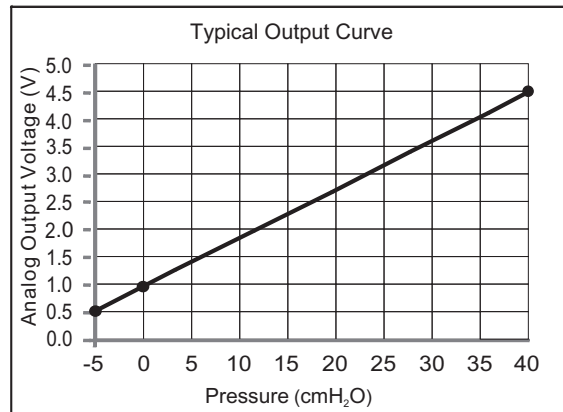

The temperature and humidity data can only be available via the I²C interface due to the limited available analog ports.

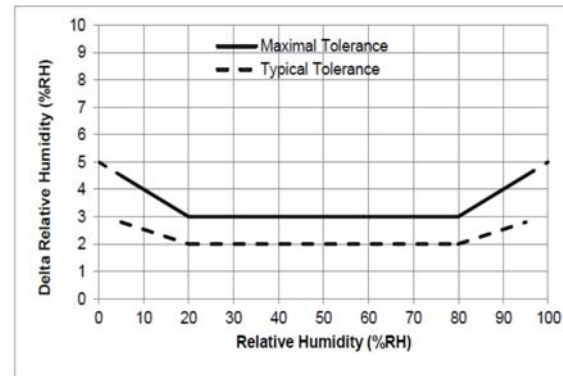

4. Pressure loss

The pressure loss was measured at 20°C and 101.325kPa. The pressure loss at the reverse flow beared the identical characteristics.

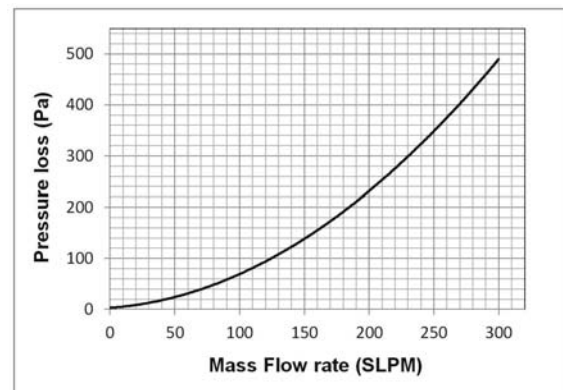

5. Electrical Interface

5.1 Pin Definition

The FS6122H provides a 6-pin interface. The output connecting cable comes with the sensor. The sensor pin layout is shown in Figure 5.1 and the cable color code is defined in Table 5.1.

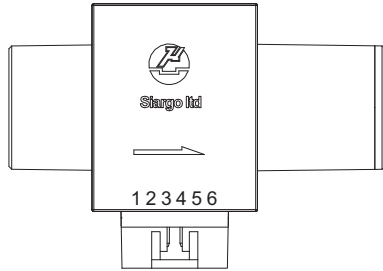

Figure 5.1: FS6122H pin layout.

Table 5.1: FS6122H pin code.

Pin	Color	Definition
1	White	Pout ¹ , Pressure sensor analog output
2	Green	Fout, Flow sensor analog output
3	Black	GND, Ground
4	Red	VCC, Power supply
5	Yellow	SCL (I ² C)
6	Blue	SDA (I ² C)

1, The pressure output can be optional.

5.2 Pin Description

VCC and GND: The FS6122H requires a power supply of 5±5% Vdc. The voltage is internally filtered and regulated to power the circuit. The sensor consumes less than 25 mA normally and the minimum supply current must be larger than 25 mA.

Pout: The pressure analog output can be optional. The pin provides 0.5 ~ 4.5 Vdc corresponding with the specified pressure full

scale range.

Fout: The flow rate analog output. The pin provides 0.5 ~ 4.5 Vdc corresponding with the specified flow full scale range.

SDA and SCL: Serial data line and serial clock line.

6. Product Order Information

6.1 Sensor Part Number

The sensor part number is composed of the product model number and suffix indicating the full scale flow rate, pressure rating, and temperature and humidity sensor integration. mechanical connection, output format as well as the application gas. Refer the following for details.

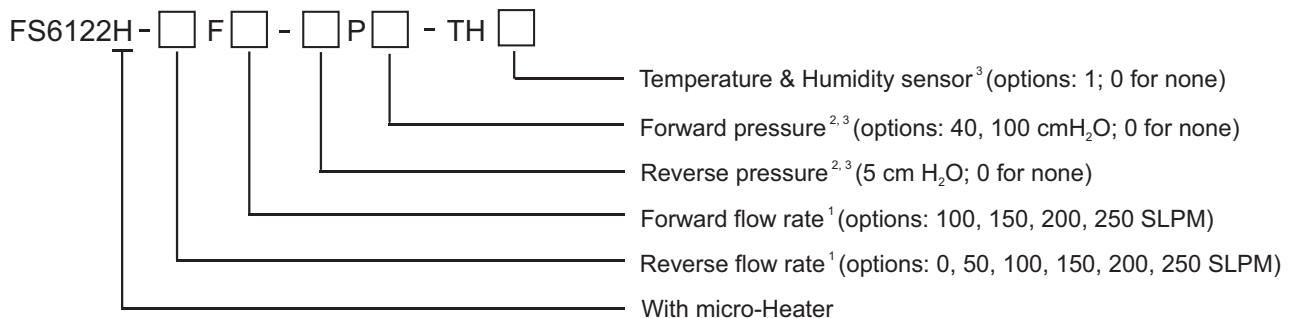

1 Numbers are for full scale flow rate, for example, 250 meaning full scale flow rate of 250SLPM. When reverse flow rate is 0, the sensor shall be configured as an uni-directional flow sensor.

2 Numbers are for full scale pressure, for example, 40 meaning full scale pressure rating of 40 cmH₂O. Other ranges are optional

3 Pressure sensor, temperature sensor and humidity sensor are optional, "-0P0-TH0" means flow sensing only models.

4 For instance, FS6122H-50F200-5P40-TH1, means flow rate of -50 to +200 SLPM, pressure rating of -5 to +40 cmH₂O and temperature and humidity sensors are integrated.

6.2 Order Contact and Customer Support

The sales offices are listed at the end of this document. For small quantities, the order can be placed either through Siargo website: www.siargo.com or the convenient sales office. For large quantities, please contact the sales office, distributors or sales representatives.

Siargo is making every effort to ensure the quality of the products. In case of questions and/or product supports, please contact customer service listed at the end of the document.

7. Mechanical Dimensions

The FS6122H provides standard ISO-22mm medical connection and can be plug-and-play for CPAP machines. The sensor has a mechanical size of 67 X 47 X 31 mm.

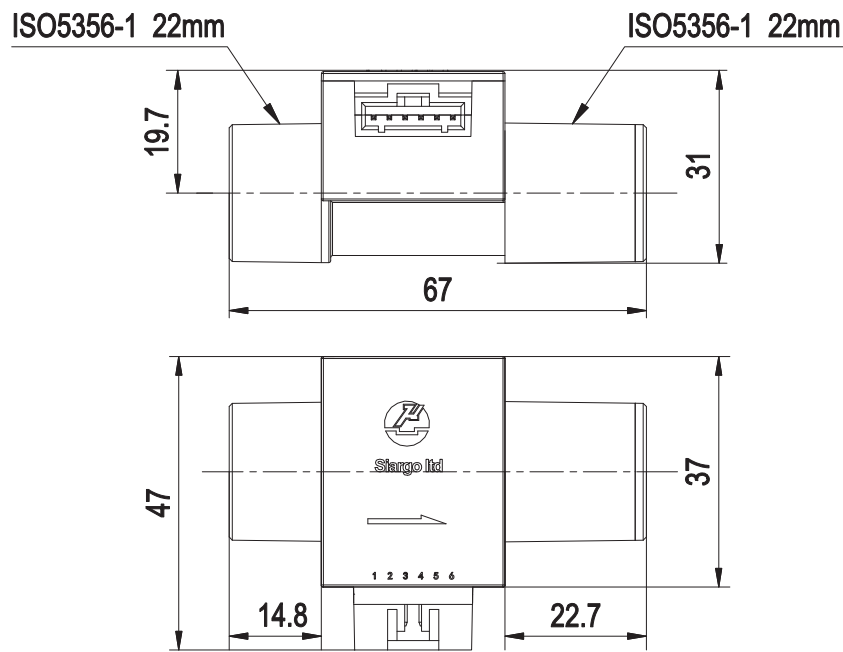



Important Notices

Wetted Materials and Compatibility

The sensor body is made of medical compatible plastics. The sensor chip comprises of silicon, silicon nitride and silicon dioxide and the sensor chip surfaces are passivated with silicon nitride and silicon dioxide. The electronic sealing is provided by RTV (room temperature vulcanizing) silicone sealant WR-704 composed of $\text{HOCH}_3(\text{SiO})_n\text{CH}_3\text{H}$.

Cautions for Handling and Installations

The product at the time of shipment is fully inspected for product quality and meets all safety requirements. Additional safety measures during handling and installation should be applied. To prevent ESD (electrostatic discharge) damage and /or degradation, take customary and statutory ESD precautions when handling. Do power the product with the correct polarity, voltage & amperage. All precautions and measures for electrical voltage handling must apply. The product sealing is ensured to work under working pressure of 30 kPa and is leakage proof before the shipment. But cautions and further leakage test are important at installation as well since any leakage could cause severe safety issue.

This product contains no user serviceable components. Do not attempt to disassemble, substitute parts or perform unauthorized modifications to the product. Doing so will forfeit the terms of the warranty and cause the liability to any damages thereafter. It should only be serviced by authorized personnel. Upon requests, Siargo will provide necessary technical support and/or training of the personnel.

Cautions for Product Applications

The product is designed for use with general purpose gases such as air and nitrogen. It is advised that the products are best used for non-explosive clean gases. The sensors cannot be used for gas metrology of fluoride or fluoride-containing gases. For updates of the product certification information, please contact the manufacturer. Use for other gases such as extreme corrosive and toxic may cause the product malfunctioning or even severe damages.

Don't expose the product's electronics other than the inner flow channel to any liquids, the unit does not have a water proof electronics. For medical sterilization procedure, please consult the manufacturer. Don't flow gas in conditions that can cause condensing water vapor to be trapped inside the unit during operation as the accuracy could be significantly influenced.

It is suggested to design your application so that nominal flow rate is approximately 70% of the full scale

flow rating of the sensor. Don't use a sensor with a flow range at the extreme cases, for instance, don't use a 200 SLPM sensor for a 2 SLPM application.

Warranty and Liability

(Effective January 2010)

Siargo warrants the products sold hereunder, properly used and properly installed under normal circumstances and service as described in this user manual, shall be free from faulty materials or workmanship for 180 days for OEM products, and 365 days for non-OEM products from the date of shipment. This warranty period is inclusive of any statutory warranty. Any repair or replacement serviced product shall bear the same terms in this warranty.

Siargo makes no other warranty, express or implied and assumes no liability for any special or incidental damage or charges, including but not limited to any damages or charges due to installation, dismantling, reinstallation or any other consequential or indirect damages of any kind. To the extent permitted by law, the exclusive remedy of the user or purchaser, and the limit of Siargo's liability for any and all losses, injuries or damages concerning the products including claims based on contract, negligence, tort, strictly liability or otherwise shall be the return of products to Siargo, and upon verification of Siargo to prove to be defective, at its sole option, to refund, repair or replacement of the products. No action, regardless of form, may be brought against Siargo more than 365 days after a cause of action has accrued. The products returned under warranty to Siargo shall be at user or purchaser's risk of loss, and will be returned, if at all, at Siargo's risk of loss. Purchasers or users are deemed to have accepted this limitation of warranty and liability, which contains the complete and exclusive limited warranty of Siargo, and it shall not be amended, modified or its terms waived except by Siargo's sole action.

This warranty is subject to the following exclusions:

- (1) Products that have been altered, modified or have been subject to unusual physical or electrical circumstances indicated but not limited to those stated in this document or any other actions which cannot be deemed as proper use of the products;
- (2) Siargo does not provide any warranty on finished goods manufactured by others. Only the original manufacturer's warranty applies;
- (3) Products re-sold to the third parties.



Contact Information

Headquarters

Siargo Ltd.
3100 De La Cruz Boulevard, Suite 210,
Santa Clara, California 95054, USA
Phone: +1-408-969-0368
Email: info@Siargo.com

Representative in US

Servoflo Corporation
75 Allen Street,
Lexington, MA 02421, USA
Phone: +1-781-862-9572
Email: info@servoflo.com

Representative in Japan

Marubeni Information Systems Co., Ltd.
Device Solutions Department
14th Floor, Shinjuku Garden Tower,
3-8-2, Okubo, Shinjuku-ku, Tokyo 169-0072, Japan
Phone: +81-3-4243-4160
Fax: +81-3-4243-4198
Email: siargo@marubeni-sys.com

Representative in Europe

IDENTIC Stefanie Trojan
In der Siedlerruh 24
69123 Heidelberg / Germany
Phone: +49-(0)6221-7509777
Fax: +49-(0)6221-7509779
Email: info@identic.de

This document is intended for distribution to customer(s) only. Siargo and its subsidiaries reserve the rights to change the specifications and/or descriptions without prior notice.