

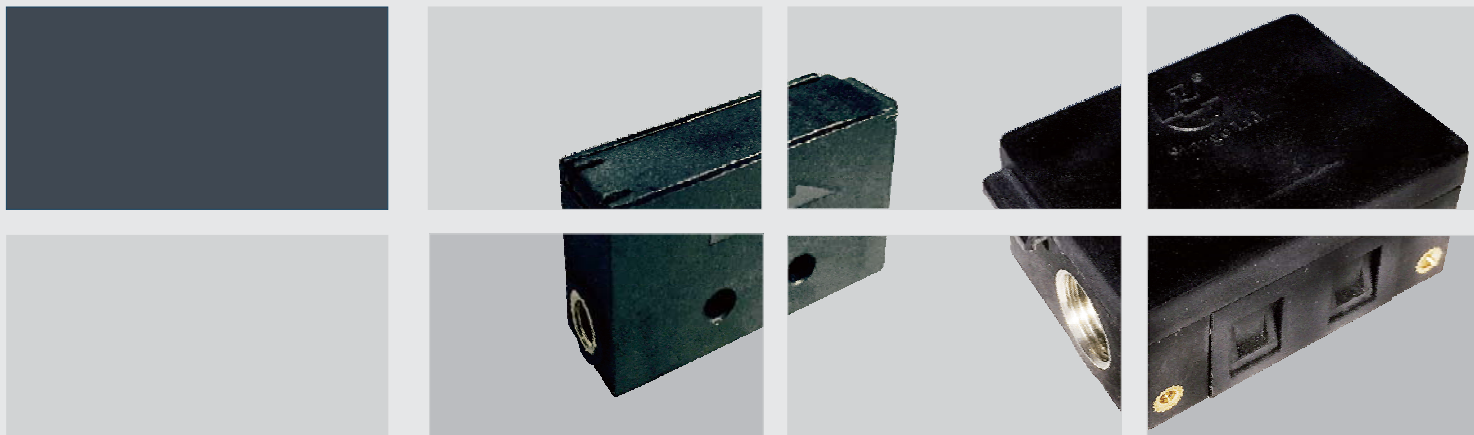

Siargo Ltd.



Model FS8000

SIARGO MEMS FLOW SENSING PRODUCTS
MEMS Mass Flow Sensors

VA.9



© 2017 Siargo Ltd.



Siargo Ltd.

MEMS Mass Flow Sensors

FS8000 Series

User Manual

Document No. 01-2017-S7 EN
Issue date: 2017.04
Revision: VA.9

Siargo Ltd.

3100 De La Cruz Boulevard,
Suite 210,
Santa Clara, CA 95054
USA

Tel: +1(408)969.0368
Email: info@siargo.com

© Copyright 2017 by Siargo Ltd.

Siargo Ltd. and its subsidiaries reserve the rights to change the specifications and/or descriptions without prior notice. For further information and updates, please visit: www.Siargo.com

MEMS Mass Flow/Clog Sensors



Siargo Ltd.

Model FS8000

Features

- Fast response time
- High sensitivity
- Low pressure drop
- Miniature design for easy installation

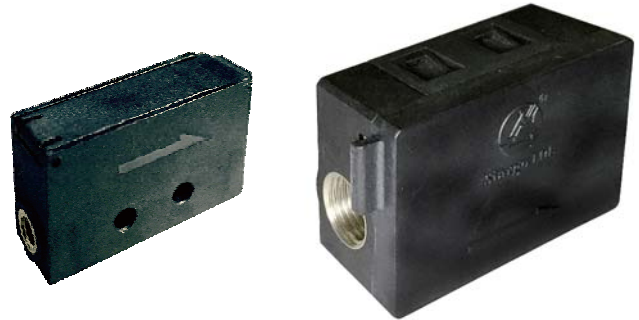

Description

The FS8000 mass flow sensors are designed and manufactured using Siargo's proprietary MEMS flow sensor and package technology.

The FS8000 mass flow sensors are developed preliminarily for die-attachment equipment air flow path control during pick and placement, and possibly for other instrumentation applications.

The packaging enclosure is made of the chemically inert and thermally stable polyphenylene sulfite (PPS) material.

The FS8000 requires a power supply of 8 ~ 24 Vdc, and provides an analog output of 0.5 ~ 4.5 Vdc corresponding to the flow rate from 0 to full scale.

Working Principle

The MEMS sensor chip utilizes the calorimetric principle. It is packaged on a plate installed inside the flow channel, which provides additional flow conditioning from the boundary layer configuration resulting in a laminar flow. The mass flow measurement is established as the gas carries heat away from the heater leading to the redistribution of the temperature field. Accurate flow rate is obtained by calibration with standard gas at preset conditions.

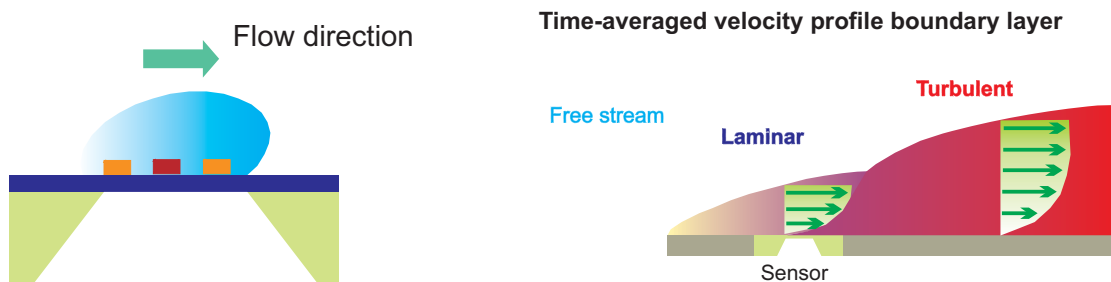

1. Sensor Performance

1.1 Performance Specifications

All data unless otherwise noted apply for measurement conditions: air, 20 °C, 101.325 kPa absolute pressure, in a fixed flow channel of 8mm in diameter.

Model	FS8001	FS8003	
Flow range	(0~500) sccm	(0~6) SLPM	
Accuracy ¹	$\pm (2+0.5FS)$		%
Repeatability	± 1.0		%FS
Output	Linear, analog voltage/l ² C		
Analog Output Range	0.5 ~ 4.5		Vdc
Null Shift	<30		mVdc
Output Shift	< ± 0.12		%/°C
Response Time	5		ms
Power Supply	8 ~ 24 Vdc, 50 mA		
Operating Current	17		mA
Max. Working Pressure	0.5		MPa
Working Temperature	0 ~ +55		°C
Storage Temperature	-20 ~ +65		°C
Humidity	< 95 %RH (No icing or condensation)		
Mechanical Connection ²	M5	Rc 1/8 (Inlet) , M5 (Outlet)	
Electrical Connector ³	SM05B-SRSS-TB (JST)		
Calibration	Air (@ 20°C , 101.325kPa)		

1 To obtain accurate flow measurement, let the sensor warm up 1 minute at power up.

While using the mounting holes the M3 screws shall be tighten carefully with a max. torque of ≤ 0.28 N·m to obtain accuracy.

2 For M5 connector, tightening torque should be 2.1 ~ 2.8 N·m, for Rc 1/8 connector, tightening torque should be 8.5 ~ 11.8 N·m.

3 The electrical connector of the FS8000 sensor is SM05B-SRSS-TB (JST). Connector SHR-05-S (JST) is suitable for both FS8001 and FS8003, while SHR-05-S-B (JST) is suitable for FS8003.

1.2 Flow Characteristics

The FS8000 provides a linear analog output corresponding with 0 ~ full scale. The typical output characteristics of FS8001 illustrated in Figure 1.1. The data are obtained at 12 Vdc supply.

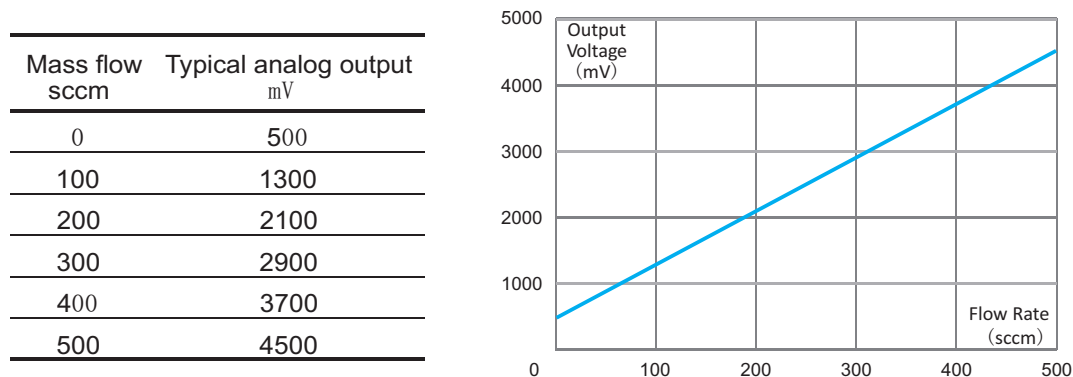

Figure 1.1: The typical analog output curve of FS8001.

Compliance Statement: All components of this product are RoHS compliant. The product fully complies with CE norm EN61000-6-1 through 61000-6-4 and EMC directive 2014/30/EU.

2. Electrical Interface

2.1 Pin Definition

The FS8000 provides a 5-pin electrical interface. The sensor pin configuration is shown in Figure 2.1.

FS8001

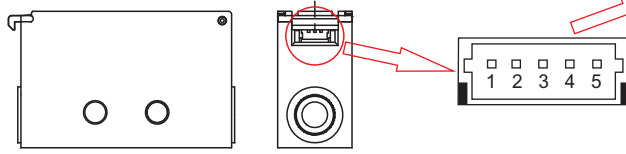

Connector of FS8001: SM05B-SRSS-TB (JST)
 Connector of Cable: SHR-05V-S (JST, without protrusions)
 Contacts: SH-003GA-P0.2 (JST, gold-plated contacts)
 or SSH-003-P0.2-H (JST, tin-plated contacts)

FS8003

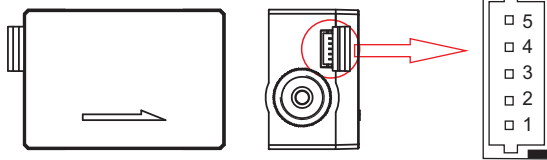

Pin	Definition
1	SCL (I ² C)
2	GND (Ground)
3	VCC (Power supply)
4	Vout (Analog output)
5	SDA (I ² C)

Connector of FS8003: SM05B-SRSS-TB (JST)
 Connector of Cable: SHR-05V-S-B (JST, with protrusions)
 or SHR-05V-S (JST, without protrusions)
 Contacts: SH-003GA-P0.2 (JST, gold-plated contacts)
 or SSH-003-P0.2-H (JST, tin-plated contacts)

Figure 2.1: FS8000 pin configuration.

2.2 Pin Description

VCC and GND: The FS8000 requires a power supply of 8~24 Vdc. The voltage is internally filtered and regulated to power the circuit. The sensor output is dependent on the accuracy of the power supply and the $\pm 5\%$ power accuracy will ensure the performance. The sensor consumes less than 10 mA normally but the minimum supply current must be larger than 10 mA for stable performance.

Vout: The analog output pin.

SDA and SCL: For I²C, please contact Siargo for protocol.

3. Mechanical Dimensions and Mountings

The FS8000 provides two mounting holes for easy installation. Be sure to align the arrow mark (on the sensor body) with the measurement flow direction. The sensor dimensions are shown in Figure 3.1.

FS8001

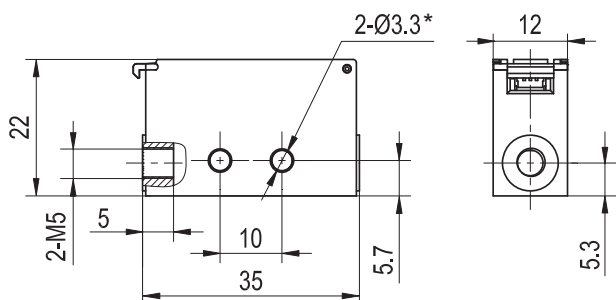

* Mounting torque of M3 screw: 0.25 ± 0.03 N·m

FS8003

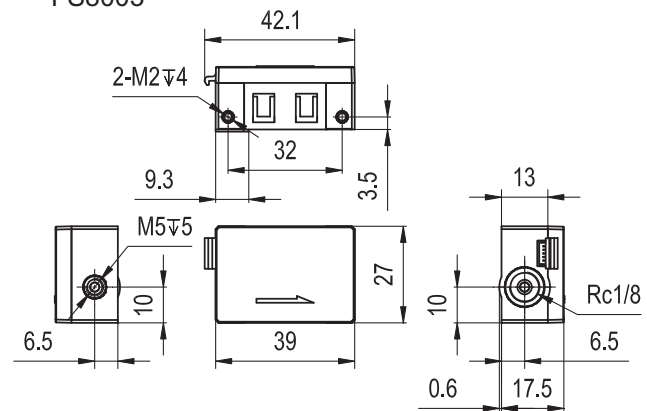

Figure 3.1: The FS8000 mechanical dimensions.



4. Ordering Guide

4.1 Sensor Selection

The sensor part number is composed of the model number and output format. Refer to the followings for details.

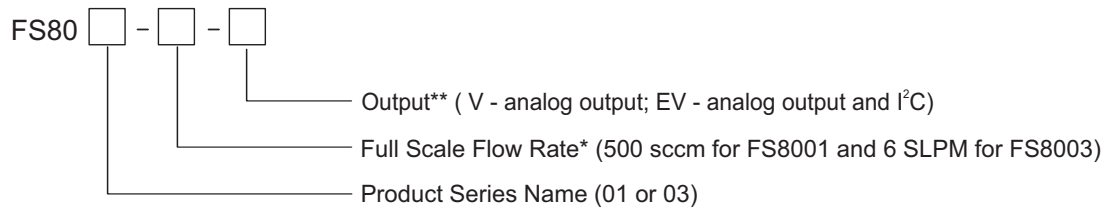

* Flow rate number only, without unit. The default unit of FS8001 is sccm, of FS8003 is SLPM.

** The sensor standard output is analog, while digital output is optional.

4.2 Order Contact and Customer Support

The sales offices are listed at the end of this document. For small quantities, the order can be placed either through Siargo website: www.siargo.com or the sales office. For large quantities, please contact the sales office or distributors or sales representatives.

Siargo is making every effort to ensure the quality of the products. In case of questions and/or product supports, please contact customer service listed at the end of the document. We will respond your request in a timely fashion and will work with you toward your complete satisfaction.



Important Notices

Wetted Materials and Compatibility

The sensor body is made of polyphenylene sulfite (PPS), brass and stainless steel. The sensor chip comprises of silicon, silicon nitride and silicon dioxide and the sensor chip surfaces are passivated with silicon nitride and silicon dioxide. The electronic sealing is provided by RTV (room temperature vulcanizing) silicone sealant WR-704 composed of HOCH_3 , $(\text{SiO})_n$, CH_3H and epoxy resin.

Cautions for Handling and Installations

The product at the time of shipment is fully inspected for product quality and meets all safety requirements. Additional safety measures during handling and installation should be applied. To prevent ESD (electrostatic discharge) damage and /or degradation, take customary and statutory ESD precautions when handling. Do power the product with the correct polarity, voltage & amperage. All precautions and measures for electrical voltage handling must apply. The product sealing is ensured to work under working pressure of 0.5 MPa and is leakage proof before the shipment. But cautions and further leakage test are important at installation as well since any leakage could cause severe safety issue.

This product contains no user serviceable components. Do not attempt to disassemble, substitute parts or perform unauthorized modifications to the product. Doing so will forfeit the terms of the warranty and cause the liability to any damages thereafter. It should only be serviced by authorized personnel. Upon requests, Siargo will provide necessary technical support and/or training of the personnel.

Cautions for Product Applications

The product is designed for use with general purpose gases such as air and nitrogen. It is advised that the products are best used for non-explosive clean gases. The sensors cannot be used for gas metrology of fluoride or fluoride-containing gases. For updates of the product certification information, please contact the manufacturer. Use for other gases such as extreme corrosive and toxic may cause the product malfunctioning or even severe damages.

Don't expose the product's electronics other than the inner flow channel to any liquids, the unit does not have a water proof electronics. Don't flow gas in conditions that can cause condensing water vapor to be trapped inside the unit during operation as the accuracy could be significantly influenced.

It is suggested to design your application so that nominal flow rate is approximately 70% of the full scale flow rating of the sensor. Don't use a sensor with a flow range at the extreme cases, for instance, don't use a 6 SLPM sensor for a 0.6 SLPM application.

Warranty and Liability

(Effective January 2010)

Siargo warrants the products sold hereunder, properly used and properly installed under normal circumstances and service as described in this user manual, shall be free from faulty materials or workmanship for 180 days for OEM products, and 365 days for non-OEM products from the date of shipment. This warranty period is inclusive of any statutory warranty. Any repair or replacement serviced product shall bear the same terms in this warranty.

Siargo makes no other warranty, express or implied and assumes no liability for any special or incidental damage or charges, including but not limited to any damages or charges due to installation, dismantling, reinstallation or any other consequential or indirect damages of any kind. To the extent permitted by law, the exclusive remedy of the user or purchaser, and the limit of Siargo's liability for any and all losses, injuries or damages concerning the products including claims based on contract, negligence, tort, strictly liability or otherwise shall be the return of products to Siargo, and upon verification of Siargo to prove to be defective, at its sole option, to refund, repair or replacement of the products. No action, regardless of form, may be brought against Siargo more than 365 days after a cause of action has accrued. The products returned under warranty to Siargo shall be at user or purchaser's risk of loss, and will be returned, if at all, at Siargo's risk of loss. Purchasers or users are deemed to have accepted this limitation of warranty and liability, which contains the complete and exclusive limited warranty of Siargo, and it shall not be amended, modified or its terms waived except by Siargo's sole action.

This warranty is subject to the following exclusions:

- (1) Products that have been altered, modified or have been subject to unusual physical or electrical circumstances indicated but not limited to those stated in this document or any other actions which cannot be deemed as proper use of the products;
- (2) Siargo does not provide any warranty on finished goods manufactured by others. Only the original manufacturer's warranty applies;
- (3) Products re-sold to the third parties.



Contact Information

Headquarters

Siargo Ltd.
3100 De La Cruz Boulevard, Suite 210,
Santa Clara, California 95054, USA
Phone: +1-408-969-0368
Email: info@Siargo.com

Representative in US

Servoflo Corporation
75 Allen Street,
Lexington, MA 02421, USA
Phone: +1-781-862-9572
Email: info@servoflo.com

Representative in Japan

Marubeni Information Systems Co., Ltd.
Device Solutions Department
14th Floor, Shinjuku Garden Tower,
3-8-2, Okubo, Shinjuku-ku, Tokyo 169-0072, Japan
Phone: +81-3-4243-4160
Fax: +81-3-4243-4198
Email: siargo@marubeni-sys.com

Representative in Europe

IDENTIC Stefanie Trojan
In der Siedlerruh 24
69123 Heidelberg / Germany
Phone: +49-(0)6221-7509777
Fax: +49-(0)6221-7509779
Email: info@identic.de

This document is intended for distribution to customer(s) only. Siargo and its subsidiaries reserve the rights to change the specifications and/or descriptions without prior notice.



Appendix: Revision History

Revision A.9 (April 2017):

- ✎ Added notes of accuracy (1.1 Performance Specifications);
- ✎ Added cable connectors information (2.1 Pin Definition);
- ✎ Added the mounting screw torque (3. Mechanical Dimensions and Mountings);
- ✎ Added the revision history (Appendix).

Revision A.8 (January 2017):

- ✎ Added the connectors information (1.1 Performance Specifications).